

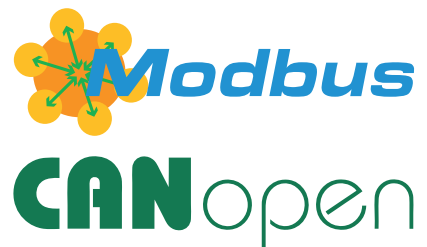

User Manual

EE072

**Humidity and Temperature Probe
with Digital Interface**



YOUR PARTNER IN SENSOR TECHNOLOGY **E+E**

ELEKTRONIK®
Ges.m.b.H.

E+E Elektronik Ges.m.b.H. doesn't accept warranty and liability claims neither upon this publication nor in case of improper treatment of the described products.

The document may contain technical inaccuracies and typographical errors. The content will be revised on a regular basis. These changes will be implemented in later versions. The described products can be improved and changed at any time without prior notice.

© Copyright E+E Elektronik Ges.m.b.H. All rights reserved.

EMC note USA (FCC):

This equipment has been tested and found to comply with the limits for a Class A digital device, pursuant to part 15 of the FCC Rules. These limits are designed to provide reasonable protection against harmful interference when the equipment is operated in a commercial environment. This equipment generates, uses, and can radiate radio frequency energy and, if not installed and used in accordance with the instruction manual, may cause harmful interference to radio communications. Operation of this equipment in a residential area is likely to cause harmful interference in which case the user will be required to correct the interference at his own expense.

EMC note Canada (ICES-003):

CAN ICES-3 (A) / NMB-3 (A)

CONTENT

1	General	4
1.1	Explanation of Symbols	4
1.2	Safety Instructions	4
1.2.1	General Safety Instructions	4
1.2.2	Intended Use	4
1.2.3	Mounting, Start-up and Operation	5
1.3	Environmental Aspects	5
2	Scope of Supply	5
3	Product Description	5
3.1	General	5
3.2	Dimensions	6
3.3	Electrical Connection	6
3.3.1	Modbus RTU Version	6
3.3.2	CANopen Version	7
3.4	Specification of the CAN Lines	7
4	Installation	7
4.1	Wall and Ceiling Mount	7
4.2	Duct Mount	8
4.3	Recommendations for accurate Humidity and Temperature Measurement	8
5	Modbus	9
5.1	Modbus Setup	9
5.2	Modbus Register Map	10
5.3	Modbus RTU Example	11
6	CANopen	12
6.1	CANopen Setup	12
6.2	Function overview	12
6.3	Electronic Datasheet (EDS)	13
6.4	Layer Setting Services (LSS)	13
7	Maintenance and Service	13
7.1	Cleaning	13
7.2	Filter Cap Replacement	13
7.3	Protection during Site Cleaning Operations	14
7.4	Repairs	14
7.5	Configuration Interface	14
7.6	RH / T Adjustment and Calibration	14
7.7	Spare Parts	15
8	Accessories	15
9	Technical Data	16

1 General

This user manual serves for ensuring proper handling and optimal functioning of the device. The user manual shall be read before commissioning the equipment and it shall be provided to all staff involved in transport, installation, operation, maintenance and repair. The user manual may not be used for the purposes of competition without the written consent of E+E Elektronik® and may not be forwarded to third parties. Copies may be made for internal purposes. All information, technical data and diagrams included in these instructions are based on the information available at the time of writing.



Please find this document and further product information on our website at www.epluse.com/EE072.

1.1 Explanation of Symbols



This symbol indicates safety information.

It is essential that all safety information is strictly observed. Failure to comply with this information can lead to personal injuries or damage to property. E+E Elektronik® assumes no liability if this happens.



This symbol indicates instructions.

The instructions shall be observed in order to reach optimal performance of the device.

1.2 Safety Instructions

1.2.1 General Safety Instructions

- Avoid any unnecessary mechanical stress and inappropriate use.
- When replacing the filter cap make sure not to touch the sensing elements.
- The device must be operated with the filter cap on at all times.
- Installation, electrical connection, maintenance and commissioning shall be performed by qualified personnel only.
- Use the EE072 only as intended and observe all technical specifications.
- Do not use EE072 in explosive atmosphere or for measurement of aggressive gases.
- Do not apply the nominal voltage to the data lines.

1.2.2 Intended Use

The EE072 is intended for highly accurate humidity (RH) and temperature (T) measurement in demanding process applications. The measured values and the calculated parameters are available on Modbus RTU or CANopen.

The use of the EE072 in any other way than described in this manual bears a safety risk for people and the entire measurement installation and is therefore not allowed.

The manufacturer cannot be held responsible for damages as a result of incorrect handling, installation, and maintenance of the equipment.

In order to avoid damage to the instrument or health hazards, the measuring equipment must never be manipulated with tools that are not specifically described in this manual.

The sensor may only be utilized in accordance with the conditions defined in the technical data. Otherwise, measurement inaccuracies will occur and equipment failures cannot be ruled out.

The steps recommended by the manufacturer for installation, inspections and maintenance work must be observed and carried out for the safety of the user and for the functionality of the equipment.

Unauthorized product modification leads to loss of all warranty claims. This may be accomplished only with an explicit permission of E+E Elektronik®!

1.2.3 Mounting, Start-up and Operation

The EE072 humidity and temperature probe has been produced under state of the art manufacturing conditions, has been thoroughly tested and has left the factory fulfilling all safety criteria. The manufacturer has taken all precautions to ensure safe operation of the device. The user must ensure that the device is set up and installed in a manner that does not have a negative effect on its safe use. The user is responsible for observing all applicable safety guidelines, local and international, with respect to safe installation and operation on the device. This user manual contains information and warnings that must be observed by the user in order to ensure safe operation.

- Mounting, start-up, operation and maintenance of the device may be performed by qualified staff only. Such staff must be authorized by the plant operator to carry out the mentioned activities.
- The qualified staff must have read and understood this user manual and must follow the instructions contained within.
- All process and electrical connections shall be thoroughly checked by authorized staff before putting the device into operation.
- Do not install or start-up a device supposed to be faulty. Make sure that such devices are not accidentally used by marking them clearly as faulty.
- A faulty device may only be investigated and possibly repaired by qualified, trained and authorized staff. If the fault cannot be fixed, the device shall be removed from the process.
- Service operations other than described in this user manual may only be performed by the manufacturer.

Disclaimer of Liability

The manufacturer or their delegated representative is only liable in case of intent or gross negligence. The accountability is limited to the value of the order issued at the time to the manufacturer. The manufacturer is not liable for damages, originated from disregarding the safety instructions or violating the instructions of the manual or operating conditions. Consequential damages are excluded from any liability.

1.3 Environmental Aspects



Products from E+E Elektronik® are developed and manufactured observing of all relevant requirements with respect to environment protection. Please observe local regulations for the device disposal.



For disposal, the individual components of the device must be separated according to local recycling regulations. The electronics shall be disposed of correctly as electronics waste.

2 Scope of Supply

- EE072 – Humidity and Temperature Probe with Digital Interface according to ordering code
- Inspection certificate according to DIN EN 10204-3.1
- Quick guide (for Modbus version only)

3 Product Description

3.1 General

The EE072 is a robust probe for relative humidity and temperature measurement. Its IP65 rating and the E+E proprietary protective sensor coating make it ideal for highest requirements. This is also underlined by the wide humidity and temperature working ranges of 0...100 %RH and -40...80 °C. The EE072 is typically implemented in demanding process and climate control applications like in agriculture, life stock, food, pharma or clean rooms. A wide choice of filter caps allow for versatile options in challenging industrial applications. Installation is simplified by various mounting options which are supported by E+E accessories.

The EE072 is available with two different interface versions, either with CANopen/CAN or with Modbus RTU over RS485. The M12x1 connector links the probe to the digital infrastructure.

3.2 Dimensions

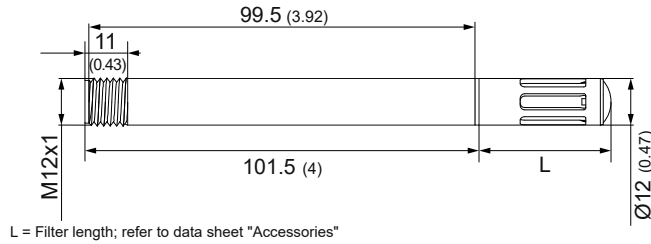

Fig. 1 Dimensions of EE072 in mm (inch)

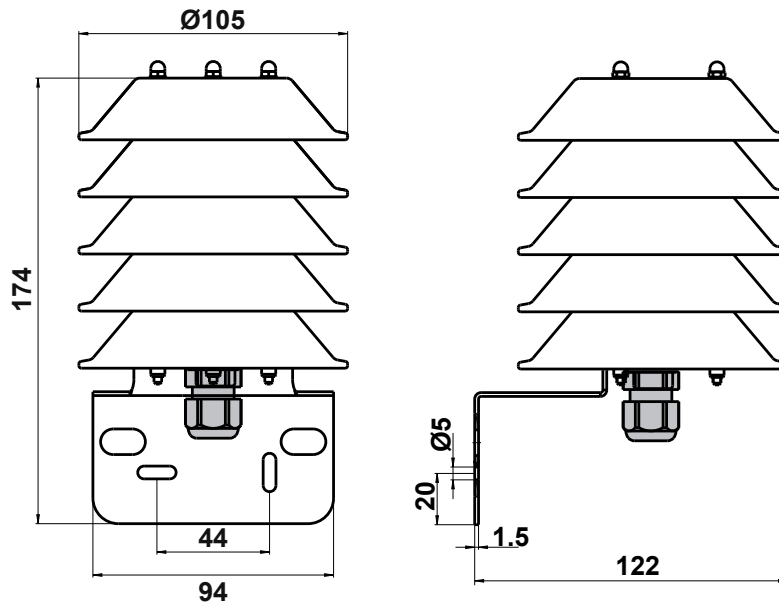

Fig. 2 Dimensions of optional radiation shield (ordering code HA010502) in mm

3.3 Electrical Connection



Important note:

The manufacturer cannot be held responsible for personal injuries or damage to property as a result of incorrect handling, installation, wiring, power supply and maintenance of the device.

The relations of electrical potential between a bus system and an EE072 humidity/temperature sensor are characterized by the following properties:

- The bus connection is not electrically isolated from the supply connection
- The individual EE072 node is not electrically isolated from the supply voltage
- Each EE072 humidity/temperature sensor can be supplied separately

3.3.1 Modbus RTU Version

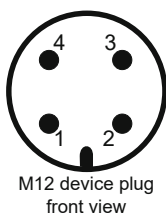

Pin number	Function	Wire colors for accessories: - Coupling flange HA010705 - Connection cable HA010819/820/821
1	Supply voltage	brown
2	B RS485 (D-)	white
3	GND	blue
4	A RS485 (D+)	black

Tab. 1 Connection to the EE072 Modbus RTU version

3.3.2 CANopen Version

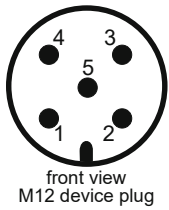

Pin number	Function	Wire colors according to ISO 11898:
1	CAN_SHLD	Not in use
2	CAN_V+	brown
3	CAN_GND	white
4	CAN_H	green
5	CAN_L	yellow

Tab. 2 Connection to the EE072 CANopen version, in accordance with CiA-303-1



In order to ensure a stable CANopen communication, the supply voltage must exceed the lower supply voltage limit of 10 V DC within two seconds after power-on.



The EE072 triggers an alarm message if the supply voltage is outside the supply limits. The lowest detectable voltage is 9 V and the highest 35 V.

3.4 Specification of the CAN Lines

The cables used for connecting the CAN bus nodes must comply with ISO 11898. Therefore, the lines must have the following characteristics:

Parameter	Bus system overall length	
	< 300 m	< 1000 m
Cable type	LIYCY 2 x 2 x 0.5 mm ² twisted pair with shielding	CYPIMF 2 x 2 x 0.5 mm ² twisted pair with shielding
Line resistance	≤ 40 Ω/km	≤ 40 Ω/km
Line capacitance	≤ 130 nF/km	≤ 60 nF/km
Connection	Pair 1 (white / brown): CAN_GND and CAN_V+ Pair 2 (green / yellow): CAN_H and CAN_L	

Tab. 3 CAN cable specification

- Only use cables that have an additional pair of wires for CAN_GND.
- Trouble-free operation of the CAN bus is only possible with correctly connected CAN_GND.
- Connect the bus termination resistors. A 120 Ω terminating resistor must be connected at each physical end of the bus system (main trunk).

4 Installation

4.1 Wall and Ceiling Mount

Best measurement performance is achieved when the entire probe is located inside the environment to be monitored.

In such a case, the EE072 may be for instance fixed onto a wall with the mounting clip HA010211 (not included in the scope of supply, see data sheet “Accessories”), or freely hang from the ceiling on the connection cable.



Fig. 3 Optional wall and ceiling mount (ordering code HA010211)

4.2 Duct Mount

The probe also can be installed into a duct using the plastic flange HA010202 or the stainless steel flange HA010201 (not included in the scope of supply, see data sheet "Accessories").



Fig. 4 Optional plastic flange (ordering code HA010202)

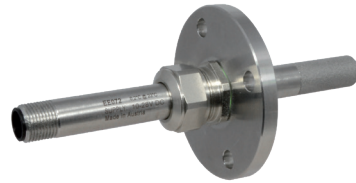



Fig. 5 Optional stainless steel flange (ordering code HA010201)

4.3 Recommendations for accurate Humidity and Temperature Measurement

- In case the EE072 probe is not entirely located in the environment to be monitored, large temperature differences along the probe will lead to temperature gradients. These will have an influence on the accuracy. Therefore, it is of paramount importance to minimize the temperature gradients. The biggest part of the probe shall be located in the target environment and the rest shall be thermally well insulated.
- For outdoor applications the EE072 shall be equipped with a radiation shield (HA010502) which provides protection from rain, snow and ice. This also causes a natural ventilation which largely prevents overheating of the probe in the sun and thus a distortion of the measured values.
- For highest accuracy of the measured humidity and the calculated parameters (e.g. wet bulb temperature, dew point and others), the user can set the barometric pressure at the operating point, using the PCS10 Product Configuration Software (see „7.5 Configuration Interface“), via Modbus protocol (see „5.1 Modbus Setup“) or via CANopen protocol. The factory setting is 1013.25 mbar.
- Best accuracy is achieved with a velocity of min. 0.2 m/s of the air surrounding the probe. Depending on the installation position, flow direction and flow velocity, the accuracy may decline. The following table gives a concise overview. Please note that the vertical positioning with the sensing element upside is the most sensitive one concerning accuracy. Because of possible self heating due to the sensor electronics, it is crucial to have the indicated air flow velocity.

Flow direction of medium		
←	> 0.2 m/s	> 0.2 m/s
→	Polycarbonate > 0.2 m/s Stainless steel > 2 m/s	> 0.2 m/s
↑	> 0.2 m/s	Polycarbonate > 0.2 m/s Stainless steel > 2 m/s
↓	> 0.2 m/s	> 0.2 m/s

Tab. 4 Mounting position, air velocity and accuracy

5 Modbus

5.1 Modbus Setup

	Factory settings	Selectable values (via PCS10)
Baud rate	9600	9600, 19200, 38400, 57600, 76800, 115200
Data bits	8	8
Parity	Even	None, odd, even
Stop bits	1	1, 2
Slave address	234	1...247

Tab. 5 Modbus default settings

Device address, baud rate, parity and stop bits can be set via:

1. PCS10 Product Configuration Software and the Modbus configuration adapter HA011018.
The PCS10 can be downloaded free of charge from www.epluse.com/PCS10
2. Modbus protocol in the register 60001 (0x00) and 60002 (0x01).
See Application Note Modbus AN0103 (available on www.epluse.com/EE072)

The serial number as ASCII-code is located at read register address 30001-30008 (16 bits per address). The firmware version is located at register address 30009 (bit 15...8 = major release; bit 7...0 = minor release). The sensor name is located at register address 30010.



Please note: When reading the serial number or the sensor name, it is always necessary to read all 8 registers, even if the desired information requires less.



Please note: For obtaining the correct floating point values, both registers have to be read within the same reading cycle. The measured value can change between two Modbus requests, therefore exponent and mantissa may get inconsistent.

Communication settings (INTEGER 16 bit)		
Parameter	Register number ¹⁾ [DEC]	Protocol address ²⁾ [HEX]
Write register: function code 0x06		
Slave-ID Modbus address	0001	0x00
Modbus protocol settings ³⁾	0002	0x01

1) Register number starts from 1.

2) Protocol address starts from 0.

3) For Modbus protocol settings see Application Note Modbus AN0103 (available on www.epluse.com/EE072).

INFO (read register)		
Parameter	Register number ¹⁾ [DEC]	Protocol address ²⁾ [HEX]
Read register: function code 0x03 / 0x04		
Serial number (as ASCII)	0001	0x00
Firmware version	0009	0x08
Sensor Name	0010	0x09

1) Register number starts from 1.

2) Protocol address starts from 0.

Air pressure		
Parameter	Register number ¹⁾ [DEC]	Register address ²⁾ [HEX]
Read and write register: function code 0x03 / 0x10		
Air pressure ³⁾	5001	0x1388

1) Register number starts from 1

2) Register address starts from 0

3) Ambient pressure in mbar, with 2 decimal digits (e.g. 1008.25), (Default value 1013.25 mbar)

5.2 Modbus Register Map

The measured data is saved as a 32 bit floating point values (data type FLOAT) and as 16 bit signed integer values (data type INTEGER).

FLOAT (read register):			
Parameter	Unit	Register number ¹⁾ [Dec]	Register address ²⁾ [HEX]
Read register: function code 0x03 / 0x04			
Temperature T	°C	1003	0x3EA
	°F	1005	0x3EC
	°K	1009	0x3F0
Relative humidity RH, Uw	% RH	1021	0x3FC
Water vapour partial pressure e	mbar	1101	0x44C
	psi	1103	0x44E
Dew point temperature Td	°C	1105	0x450
	°F	1107	0x452
	°K	1147	0x47A
Wet bulb temperature Tw	°C	1109	0x454
	°F	1111	0x456
	°K	1145	0x478
Absolute humidity dv	g/m ³	1113	0x458
	gr/ft ³	1115	0x45A
Mixing ratio r	g/kg	1121	0x460
	gr/lb	1123	0x462
Specific enthalpy h	kJ/kg	1125	0x464
	ft lbf/lb	1127	0x466
	BTU/lb	1129	0x468
Frost point temperature Tf	°C	1131	0x46A
	°F	1133	0x46C
	°K	1149	0x47C
Ice bulb temperature Ti	°C	1237	0x4D4
	°F	1239	0x4D6
	°K	1241	0x4D8

1) Register number starts from 1

2) Register address starts from 0

INTEGER (read register):				
Parameter	Unit	Scale ³⁾	Register number ¹⁾ [Dec]	Register address ²⁾ [HEX]
Read register: function code 0x03 / 0x04				
Temperature T	°C	100	4002	0xFA1
	°F	50	4003	0xFA2
	°K	50	4005	0xFA4
Relative humidity RH, Uw	% RH	100	4011	0xFAA
Water vapour partial pressure e	mbar	10	4051	0xFD2
	psi	1000	4052	0xFD3
Dew point temperature Td	°C	100	4053	0xFD4
	°F	100	4054	0xFD5
	°K	100	4074	0xFE9
Wet bulb temperature Tw	°C	100	4055	0xFD6
	°F	100	4056	0xFD7
	°K	100	4073	0xFE8
Absolute humidity dv	g/m ³	10	4057	0xFD8
	gr/ft ³	10	4058	0xFD9
Mixing ratio r	g/kg	10	4061	0xFDC
	gr/lb	10	4062	0xFDD
Specific enthalpy h	kJ/kg	1	4063	0xFDE
	ft lbf/lb	1	4064	0xFDF
	BTU/lb	1	4065	0xFE0
Frost point temperature Tf	°C	100	4066	0xFE1
	°F	100	4067	0xFE2
	°K	100	4075	0FEA
Ice bulb temperature Ti	°C	100	4119	0x1016
	°F	100	4120	0x1017
	°K	50	4121	0x1018

1) Register number starts from 1

2) Register address starts from 0

3) Examples: For scale 100, the reading of 2550 means a value of 25.5. For scale 50, the reading of 2550 means a value of 51.

5.3 Modbus RTU Example

Example of MODBUS RTU command for reading the temperature (float value) T = 26,953624 °C from the register 0x3EA

- Device EE072; slave ID 234 [0xEA]
Reference document, chapter 6.3: www.modbus.org/docs/Modbus_Application_Protocol_V1_1b.pdf
- See Application Note Modbus AN0103 (available on www.epluse.com/EE072)

	Modbus ID address	Function code	Starting address Hi	Starting address Lo	No. of register Hi	No. of register Lo	CRC	
Request [Hex]:	EA	03	03	EA	00	02	F2	A0

	Modbus ID address	Function code	Byte count	Register 1 value Hi	Register 1 value Lo	Register 2 value Hi	Register 2 value Lo	CRC	
Response Hex]:	EA	03	04	A1	06	41	D7	12	CE

Decoding of floating point values:

Floating point values are stored according IEEE754 standard. The byte pairs 1, 2 and 3, 4 are inverted as follows:

MMMMMMMM	MMMMMMMM	SEEEEEEE	EMMMMMMM
Byte 3	Byte 4	Byte 1	Byte 2

Example:

Response [Hex]				Value in decimal
Byte 1 (Register 2 - Hi)	Byte 2 (Register 2 - Lo)	Byte 3 (Register 1 - Hi)	Byte 4 (Register 1 - Lo)	
41	D7	A1	06	26.953624

6 CANopen

6.1 CANopen Setup

	Factory settings	Selectable parameters	Configurable via
Baud rate	125 kBit/s	125 kBit/s, 250 kBit/s, 500 kBit/s, 800 kBit/s, 1MBit/s	PCS10 or LSS
Node ID	64	1...127	PCS10 or LSS
TPDO 1	T in [°C], Uw in [%]	T, Uw, e, Td, Tw, dv, r, h, Tf, Ti	CAN SDO
TPDO 2	e in [mbar], Td in [°C]	T, Uw, e, Td, Tw, dv, r, h, Tf, Ti	CAN SDO
TPDO 3	r in [g/kg], h in [kJ/kg]	T, Uw, e, Td, Tw, dv, r, h, Tf, Ti	CAN SDO
TPDO 4	Tf in [°C], Ti in [°C]	T, Uw, e, Td, Tw, dv, r, h, Tf, Ti	CAN SDO
TPDO data type	REAL32	REAL32, INTEGER16	CAN SDO

Abbreviations: TPDO Transceive Process Data Object
 PCS10 E+E Product Configuration Software (see chapter 7.5 Configuration Interface)
 LSS Layer Setting Services (see chapter 6.4 Layer Setting Services (LSS))
 CAN SDO Service Data Object

Tab. 6 CANopen default settings

Parameter	Symbol	Condition	Units
Temperature	T		[°C, °F, K]
Relative humidity	Uw, RH		[%]
Water vapour partial pressure	e		[mbar, psi]
Dew point temperature	Td		[°C, °F, K]
Wetbulb temperature	Tw	Tw ≥ 0 °C	[°C, °F, K]
Water vapour density (absolute humidity)	dv		[g/m ³]
Mixing ratio	r		[g/kg]
Specific enthalpy	h		[kJ/kg]
Frost point temperature	Tf	Tf ≤ 0 °C	[°C, °F, K]
Ice bulb temperature	Ti	Ti ≤ 0 °C	[°C, °F, K]

Tab. 7 Selectable parameters

6.2 Function overview

The EE072 humidity/temperature probes have a standardised CANopen interface according to CiA DS-301 and a device profile according to CiA DSP-404. All measured values and parameters are accessible via the object directory (OD). The individual configuration can be saved in the internal permanent memory (EEPROM).

The following CANopen functions are available:

- Transceive Process Data Objects (TPDO 1 - 4) in four possible operating modes:
 - individual query via Remote Transmit Request (RTR)
 - cyclic transmission by interval time
 - event-controlled transmission on measurand change
 - synchronized transmission after receipt of a SYNC telegram
- Service Data Object (standard SDO)
- Error messages via Emergency Object (EMCY) with support:
 - the general error register (Error Register)
 - the manufacturer-specific status register (Manufacturer Status)
 - the error list (Pre-defined Error Field)
 - supply range alarm
- Monitoring mechanisms Heartbeat and Nodeguarding/Lifeguarding
- Save and restore function for all parameters (Store and Load Parameter Field)
- Setting the Node ID and the baud rate via LSS
- In addition to the CiA DS-301 functionality, there are further manufacturer or profile specific features:
 - Setting of pressure compensation parameter (object 2205_h - default value 1013.25 mbar)
 - Supply voltage monitoring
 - Read calibration date (factory and customer)

6.3 Electronic Datasheet (EDS)

An electronic data sheet (EDS) is available for the EE072 CANopen (download free of charge at E+E's EE072 webpage) .
It contains a complete description of the object dictionary and facilitates a convenient integration into a CANopen engineering software.

6.4 Layer Setting Services (LSS)

In order to use the LSS functionality, LSS data is required which clearly identifies the sensor. This is the Identity Object (Index 1018_h).

Designation	Object	Sub-Index	Value for EE072
Vendor ID	1018 _h	01 _h	000004C8 _h
Product code	1018 _h	02 _h	0x00 _h
Revision number	1018 _h	03 _h	0x00 _h
CANopen serial number	1018 _h	04 _h	device specific (LLS – 04h: 0x....)

The sensor specific identifier (LLS – 04h) is printed on each EE072.

Example of sensor labeling including LSS data:

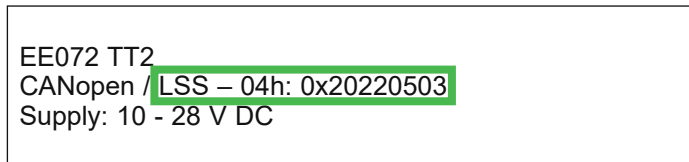

7 Maintenance and Service

EE072 does not require any special maintenance, nevertheless for high accurate measurements especially over wide RH and T ranges it is recommended to calibrate the probe every 12 months. If needed, the enclosure may be cleaned and the device may be re-adjusted as described below.

7.1 Cleaning

Use a damp soft cloth to remove deposits of dust or dirt from the exterior of the probe. Do not use any solvents or abrasive cleaning agents.

In case of dusty, oily and polluted environment:

- Use a damp soft cloth to remove deposits of dust or dirt from the exterior of the probe. Do not use any solvents or abrasive cleaning agents.
- The filter cap shall be replaced once in a while with an E+E original one (see below).
- If needed, the sensing element of the humidity probe can be cleaned by the user (see cleaning instruction - www.epluse.com/cleaning-instructions)

7.2 Filter Cap Replacement

In a dusty or polluted environment it might be necessary to replace the filter cap once in a while. In most of the cases, a clogged filter shows visible contamination or dirt. Longer response time of the humidity measurement also indicates a clogged filter cap. In such cases, replace the filter by a new, original one, see „7.7 Spare Parts“.



Procedure

- Turn the filter cap counter-clockwise for removing it.
- Install the new filter cap finger tight by turning it clockwise.



While replacing the filter cap take very good care to not touch or rub the sensing element.

7.3 Protection during Site Cleaning Operations



During site cleaning or sterilization process, if the EE072 remains on the measuring site the sensing head can be protected with the optional protection cap for 12 mm (0.47") probe (HA010783, see datasheet "Accessories").

In case the probe is removed from the site, it is recommended to apply the protection cap for the M12 cable socket (HA010781) and the one for the EE072 M12 plug of (HA010782).



Fig. 6 Protection cap for Ø12 mm (0.47") probe (ordering code HA010783)



Fig. 7 Protection cap M12 female connector (ordering code HA010781)



Fig. 8 Protection cap M12 female connector (ordering code HA010782)

7.4 Repairs

Repairs may be carried out by the manufacturer only. The attempt of unauthorized repair excludes any warranty claims.

7.5 Configuration Interface

The EE072 is ready to use and does not require any configuration by the user. The user can change the factory setup by using the configuration adapter (Modbus: HA011018 / CAN: HA011021) and the PCS10 Product Configuration Software.

With the PCS10, it is possible to change the digital communication settings and to perform a RH and T adjustment in the form of an offset or as a 2-point adjustment. For the purpose of pressure compensation, the barometric air pressure at the operating site may be set.

PCS10 PRODUCT CONFIGURATION SOFTWARE

1. Download the PCS10 Product Configuration Software from www.epluse.com/pcs10 and install it on the PC.
2. Connect the E+E device to the PC using the appropriate configuration cable.
3. Start the PCS10 software.
4. Follow the instructions on the PCS10 opening page for scanning the ports and identifying the connected device.
5. Click on the desired setup or adjustment mode from the main PCS10 menu on the left and follow the online instructions of the PCS10.

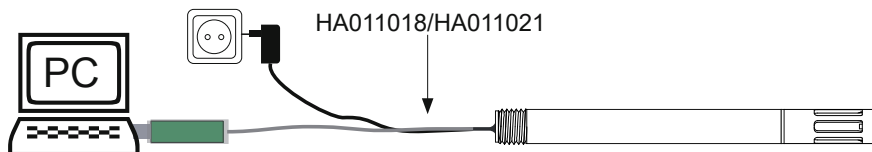

7.6 RH / T Adjustment and Calibration

Definition

- Adjustment
the specimen is brought in line with the reference.
- Calibration
the specimen is compared with a reference and its deviation from the reference is documented.

Humidity calibration and adjustment

Depending on the application and the requirements of certain industries, there might arise the need for periodical humidity calibration (comparison with a reference) or adjustment (bringing the device in line with a reference).

Calibration and adjustment at E+E Elektronik

Calibration and/or adjustment can be performed in the E+E Elektronik calibration laboratory. For information on the E+E capabilities in ISO or accredited calibration please see www.eplusecal.com.

Calibration and adjustment by the user

Depending on the level of accuracy required, the humidity reference can be:

- Humidity calibrator (e.g. Humor 20), please see www.epluse.com/humor20.
- Handheld device (e.g. Omniport 30), please see www.epluse.com/omniport30.
- Humidity standards (e.g. Humidity Calibration Kit), please see www.epluse.com/EE072.

7.7 Spare Parts

Description	Order code
Filter caps for probes with Ø 12 mm	Please refer to the datasheet "Accessories"

8 Accessories

General	Order code
E+E Product Configuration Software (Download: www.epluse.com/PCS10)	PCS10
Protection cap for the M12 cable socket	HA010781
Protection cap for the M12 plug of EE072	HA010782
Protection cap for 12 mm probe	HA010783
Stainless steel mounting flange	HA010201
Plastic mounting flange	HA010202
T-coupler M12 - M12	HA030204
Wall mounting clip	HA010211
Radiation shield for probes with Ø12mm	HA010502
Drip water protection	HA010503
Modbus	Order code
M12 cable connector for self assembly, 4 pole	HA010707
Modbus configuration adapter	HA011018
Connection cable, 5 pole, M12x1 socket - free ends, PUR insulation	
1.5 m (4.9 ft)	HA010819
5 m (16.4 ft)	HA010820
10 m (32.8 ft)	HA010821
CAN	Order code
M12 cable connector for self assembly, 5 pole	HA010708
CAN configuration adapter	HA011021

9 Technical Data

Measurands

Relative humidity

Accuracy¹⁾ (incl. hysteresis, non-linearity and repeatability)

-15...40 °C (5...104 °F)

$\pm (1.3 + 0.3 \% \cdot mv) \%RH$ for RH $\leq 90 \%$

$\pm 2.3 \%$ for RH $> 90 \%$

-40...80 °C (-40...176 °F)

$\pm (1.5 + 1.5 \% \cdot mv) \%RH$

mv = measured value

Response time

$< 15 \text{ s}$ with stainless steel grid filter at 20 °C (68 °F) / t_{90}

Resolution

0.01 %RH

Temperature

Accuracy¹⁾

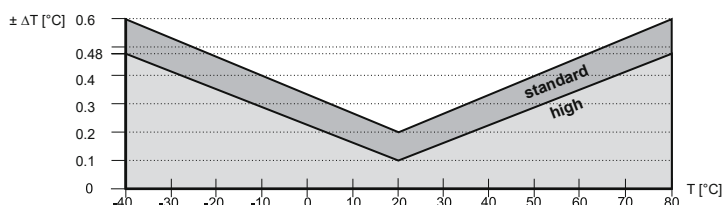

Resolution

0.01 °C

General

Sensing element

E+E HCT01 with E+E proprietary coating

Measuring interval

1 s

Supply

10 - 28 V DC

Current consumption, typ.

3 mA (RS485, without termination resistor)
8 mA (CAN)

Enclosure

Polycarbonate RAL 7035 / Stainless steel 1.4404 / AISI 316

Protection rating²⁾

IP65

Electromagnetic compatibility

EN 61326-1:2013 EN 61326-2-3:2013
Industrial Environment
FCC Part15 ClassA ICES-003 ClassA



Working range

-40...80 °C (-40...176 °F) / 0...100 % RH

Storage conditions

-40...80 °C (-40...176 °F) / 0...90 % RH, non-condensing

Configuration and adjustment

PCS10 (Product Configuration Software, free download)
and configuration adapter

Digital Communication

RS485

Protocol

Modbus RTU

Connector

M12x1, 4 poles

Default settings

Baud rate 9600³⁾, parity even, 1 stop bit, Modbus address 234

CAN

Protocol / Profile

CANopen / device profile CiA 404

Connector

M12x1, 5 poles, pin assignment according to CiA 303-1

Default settings

Baud rate 125 kBit/s⁴⁾, node ID 64

1) Traceable to international standards, administrated by NIST, PTB, BEV,... The accuracy statement includes the uncertainty of the factory calibration with an enhancement factor $k=2$ (2-times standard deviation). The accuracy was calculated in accordance with EA-4/02 and with regard to GUM (Guide to the Expression of Uncertainty in Measurement). For Modbus, the accuracy is defined at a 12 V DC supply, baud rate 9600, without termination resistor, a polling interval of $\geq 1 \text{ s}$ and a flow velocity of $> 0.2 \text{ m/s}$. For CANopen, the accuracy is defined at a flow velocity of $> 0.2 \text{ m/s}$.

2) The IP65 rating applies when plugged into an appropriate M12x1 female connector.

3) Supported baud rates: 9600, 19200, 38400, 57600, 76800 and 115200.

For more details about communication setting see User Manual and Modbus Application Note at www.epluse.com/ee072

4) Supported baud rates: 125 kBit/s, 250 kBit/s, 500 kBit/s, 800 kBit/s, 1 MBit/s.

For further information on the configuration see software instruction manual and the EDS file (Electronic Data Sheet).



HEADQUARTERS

E+E Elektronik Ges.m.b.H.

Langwiesen 7
4209 Engerwitzdorf
Austria
Tel.: +43 7235 605-0
E-mail: info@epluse.com
Web: www.epluse.com

SUBSIDIARIES

E+E Elektronik China

18F, Kaidi Financial Building,
No.1088 XiangYin Road
200433 Shanghai
Tel.: +86 21 6117 6129
E-mail: info@epluse.cn

E+E Elektronik France

Le Norty III, 136 chemin du Moulin
69130 Ecully
Tel.: +33 4 74 72 35 82
E-mail: info@epluse.fr

E+E Elektronik Germany

Schöne Aussicht 8 C
61348 Bad Homburg
Tel.: +49 6172 13881-0
E-mail: info@epluse.de

E+E Elektronik Italy

Via Alghero 17/19
20128 Milano (MI)
Tel.: +39 02 2707 86 36
E-mail: info@epluse.it

E+E Elektronik Korea

Suite 2001, Heungdeok IT
Valley Towerdong, 13,
Heungdeok 1-ro, Giheung-gu
16954 Yongin-si, Gyeonggi-do
Tel.: +82 31 732 6050
E-mail: info@epluse.co.kr

E+E Elektronik USA

333 East State Parkway
Schaumburg, IL 60173
Tel.: +1 847 490 0520
E-mail: office@epluse.com

YOUR PARTNER IN SENSOR TECHNOLOGY



ELEKTRONIK®
Ges.m.b.H.